

# Multiple Channel Configurations - Cables

## SSMP

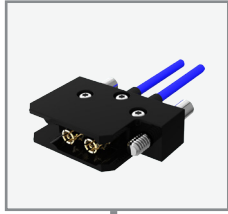

2 Position

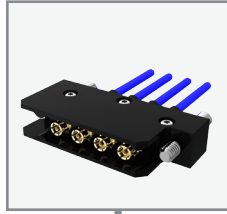

4 Position

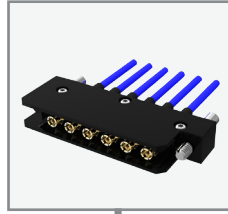

6 Position

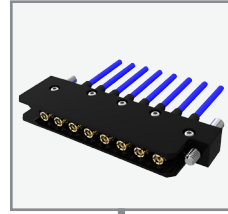

8 Position



10 Position

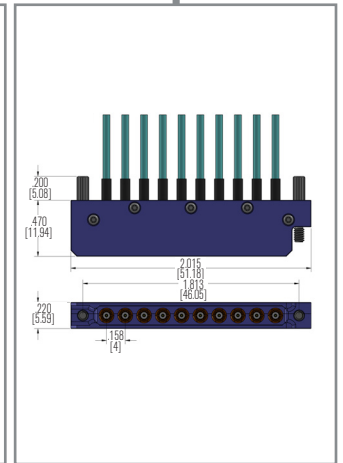
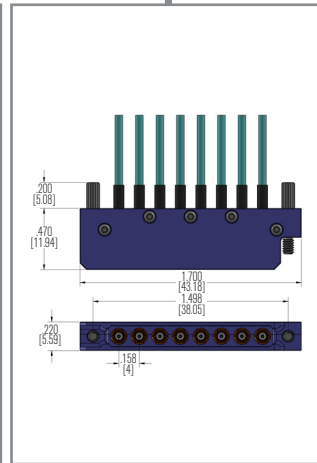
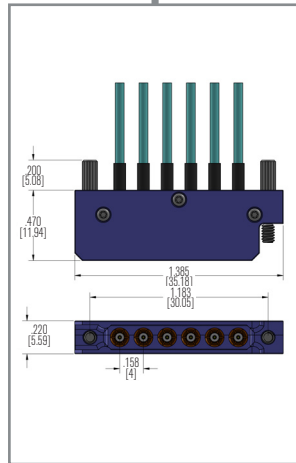
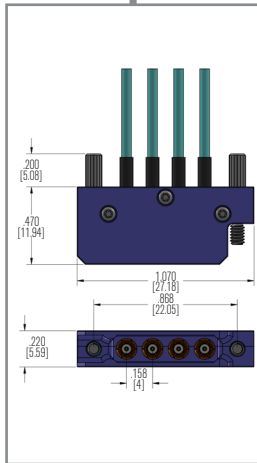
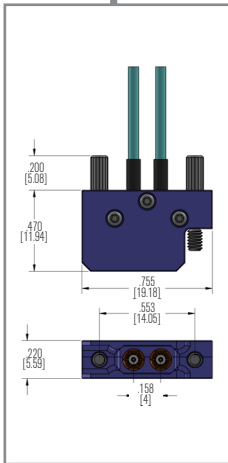

## WMP

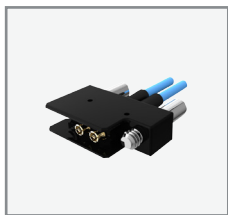

2 Position

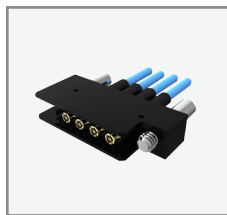

4 Position

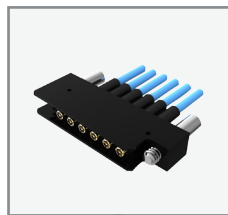

6 Position

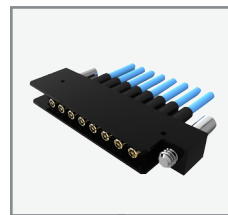

8 Position

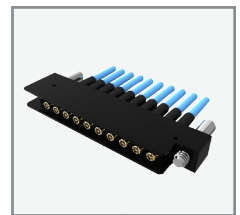

10 Position

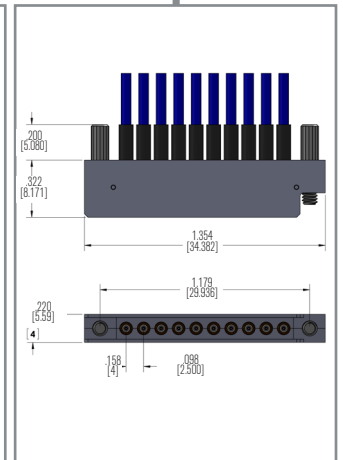
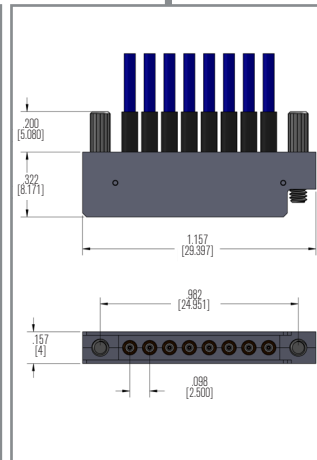
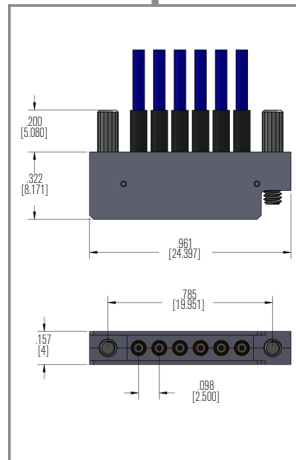
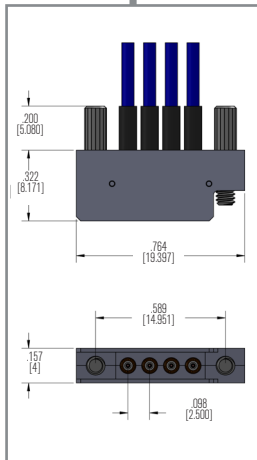
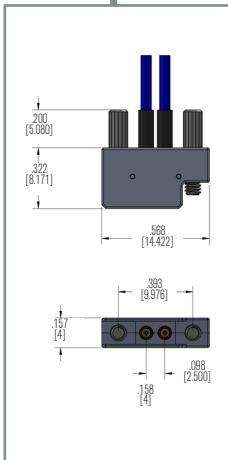

# Multiple Channel Configurations - Connectors

## SSMP PCB Connectors - Vertical Mount

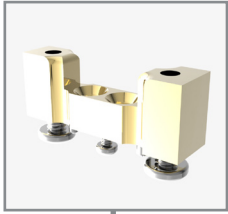

2 Position

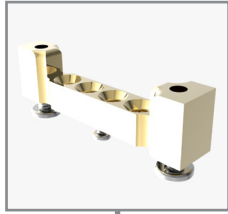
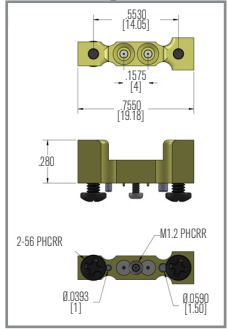

4 Position

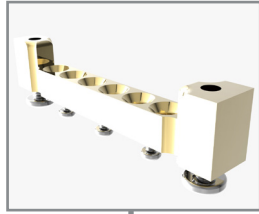
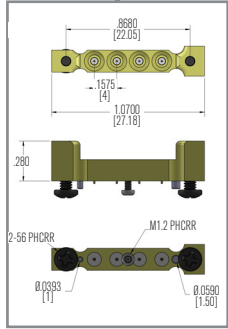

6 Position

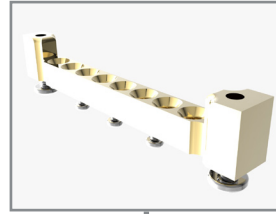
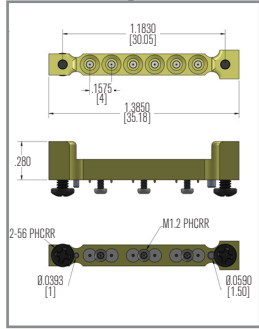

8 Position

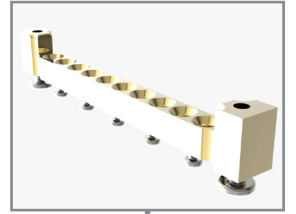
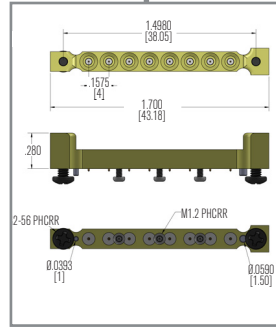

10 Position

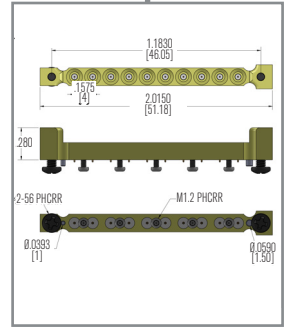

## WMP PCB Connectors - Vertical Mount



2 Position

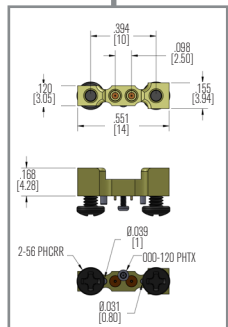

4 Position

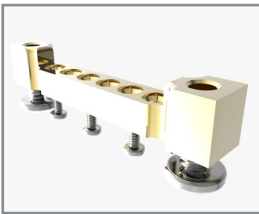
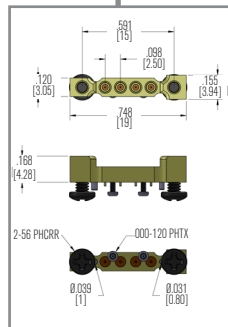

6 Position

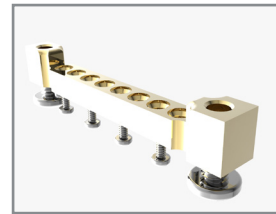
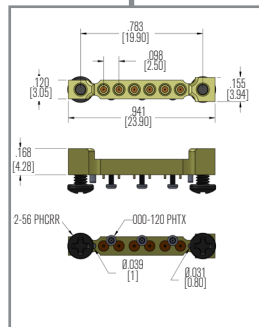

8 Position

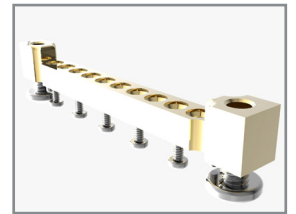
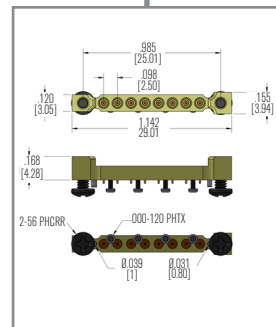

10 Position

